

Energia stoccata in serbatoi interrati

Dimensioni e misure per l'installazione

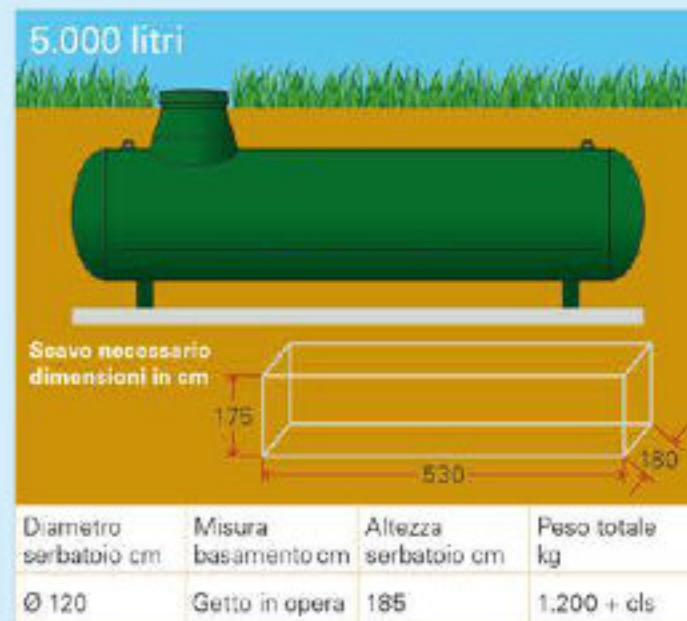
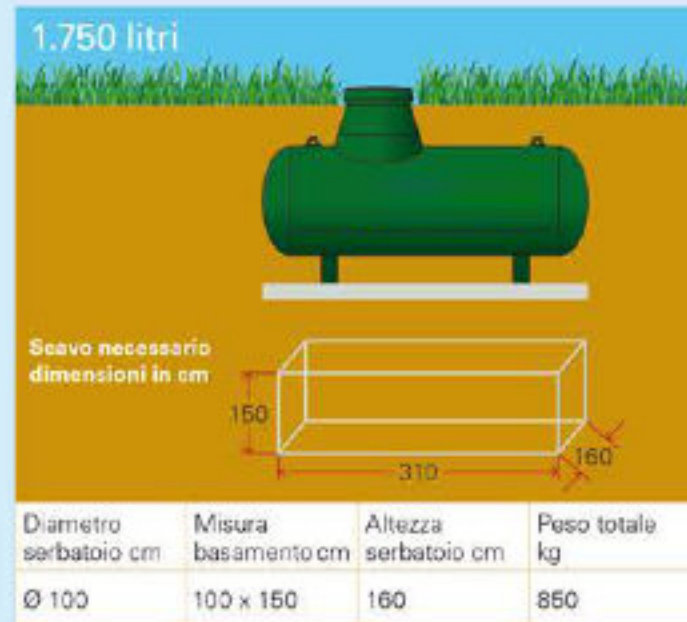
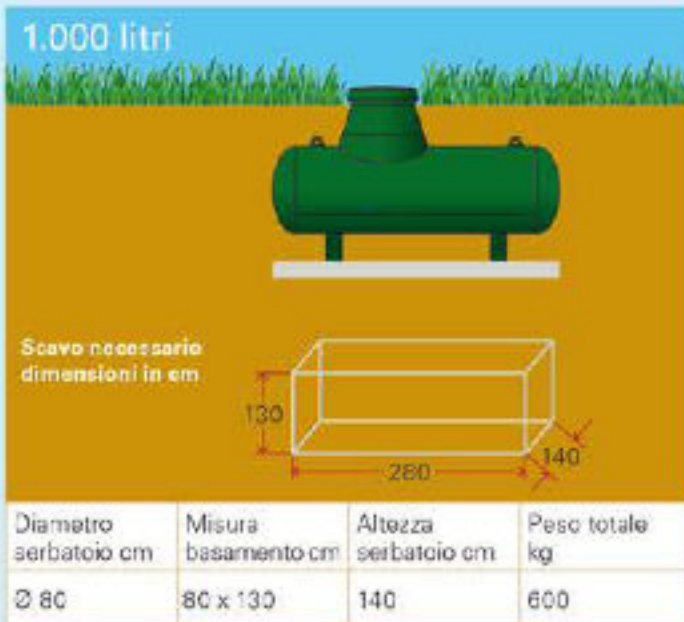
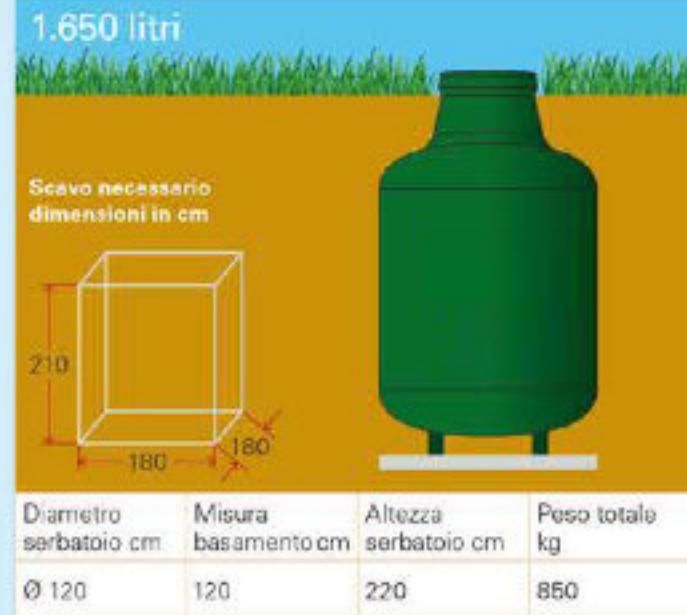
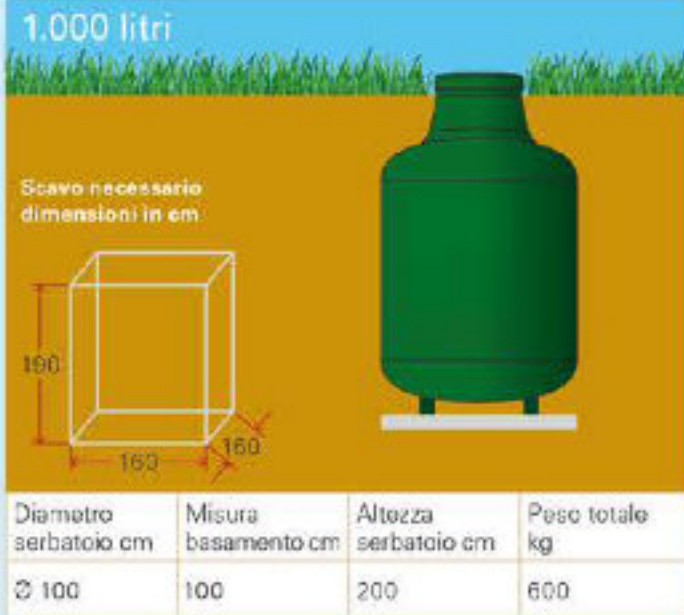

Attenzione. Prima di iniziare i lavori contattare un nostro tecnico.

Energia stoccata in serbatoi fuori terra

Dimensioni e misure per l'installazione

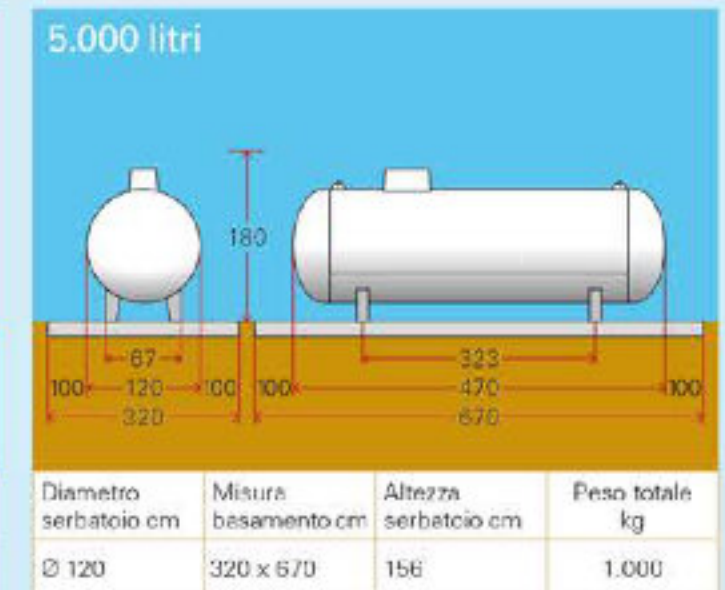
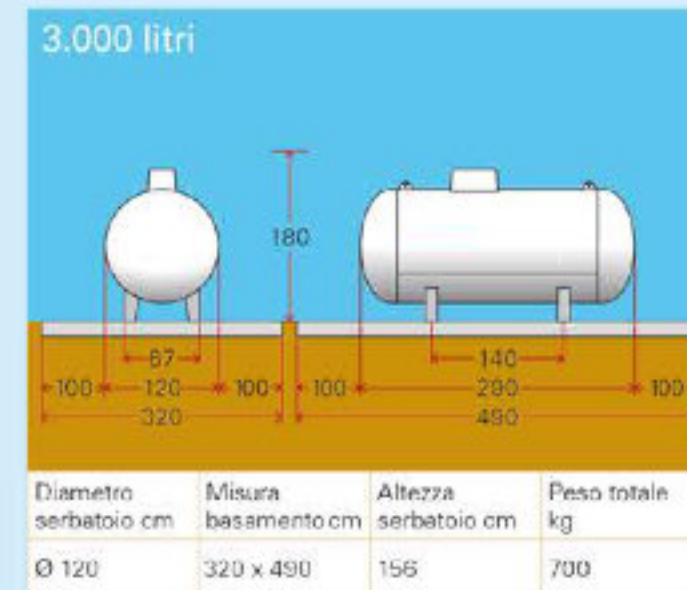
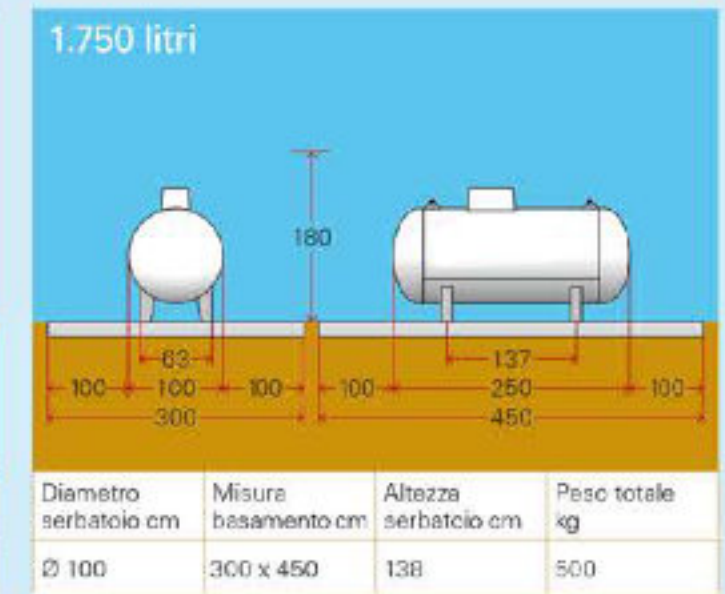
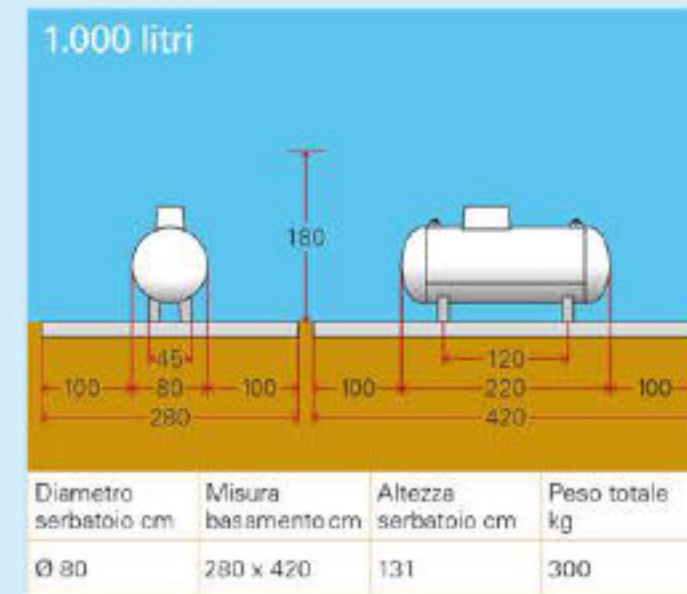
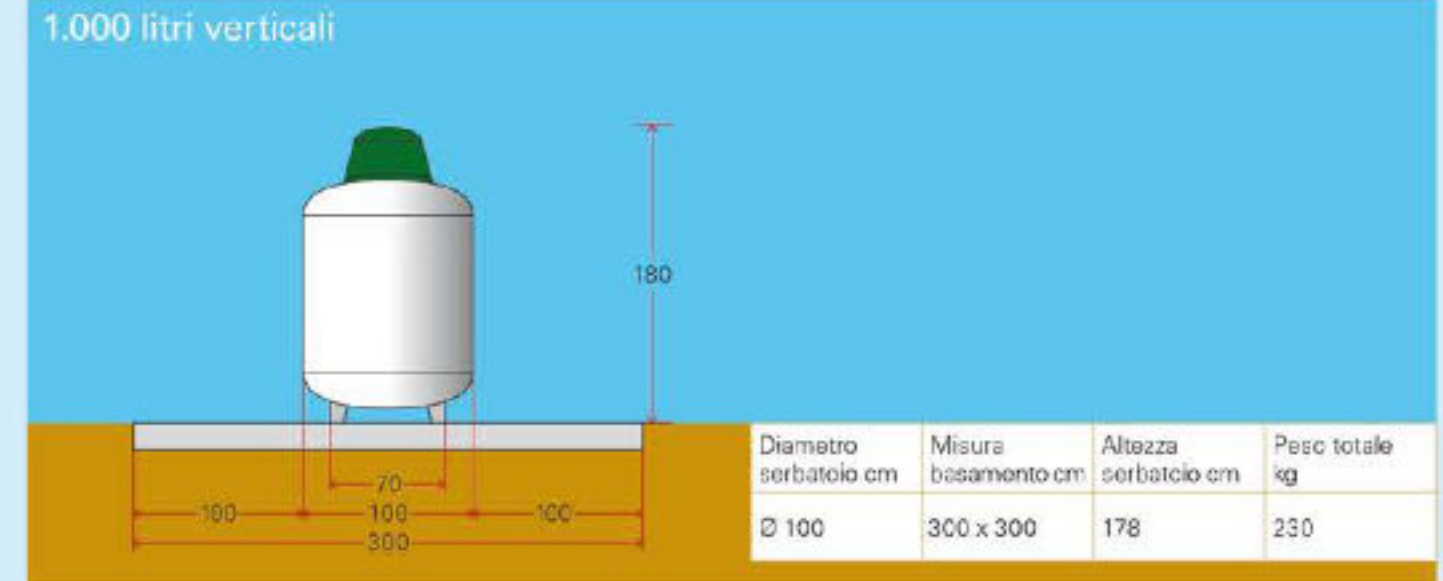

NB. Nella recinzione va apposta una porta di 90 cm apribile verso l'esterno. Nel caso in cui nel raggio di 5 m attorno al serbatoio vi sia vegetazione, occorre predisporre alla base della recinzione un muro di contenimento alto 50 cm.

Attenzione. Prima di iniziare i lavori contattare un nostro tecnico.